

HORIZON



Installation Instructions Horizon Three Sided
Natural Draft Electronic Ignition
Gas Fireplaces

Installation Instructions Kemlan Three Sided Natural Draft Electronic Ignition Gas Fireplaces

SUITABLE GAS BURNER OPTION

SINGLE SIDED MODELS

1100 Edge	1000 Mk2 Pebble 1000 Mk2 Coal 850 Ironbark Log Mk4
1500 Edge	1400 Mk2 Pebble 1400 Mk2 Coal
2000 Edge	1800 Mk2 Pebble 1800 Mk2 Coal

Model Type 2: Natural Draft Electronic Ignition Gas Fireplace

DATA PLATE: Refer to information on page 13 of this Instruction booklet in respect to gas pressure, consumption and gas type, Natural, ULPG or LPG.

Data Plate is located under the gas burner and is accessed by lifting front access panel or removing base plate.

Location Requirements

Power flue systems utilizes a fan assisted draft to ensure products of combustion are exited through a flue terminal either horizontally or vertically terminated.

The following Australian location requirements for flues are to be observed when installing a powered flue system.

Ventilation Requirements:

Rooms with gas open fireplaces require as per clause 6.10.9.5 in AS/NZS5601.1:2013, one or more ventilation openings with a combined free ventilation area of not less than the equivalent cross section area of the flue cowl shall be provided for each decorative flame effect fire, and calculations based on clause 6.4.4

“THIS APPLIANCE REQUIRES FRESH AIR TO OPERATE SAFELY. THE ROOM WHERE THIS APPLIANCE IS INSTALLED MUST HAVE PERMANENT VENTILATION FROM OUTDOORS, IN ACCORDANCE WITH THE VENTILATION REQUIREMENTS OF AS/NZS 5601”

NOTE: The chimney in which the appliance is installed is not to be considered as a ventilation opening.

Installation Instructions Kemlan Three Sided Natural Draft Electronic Ignition Gas Fireplaces

Before Installation

The Natural Draft Electronic Ignition (N.D.E.I.) flue system shall be installed by authorized personnel in accordance with the manufacturer's installation instructions, local gas fitting regulations, municipal building codes, electrical wiring regulations, and any other statutory regulations. Contact your local building authorities about restrictions and installation inspections that may be required. If in doubt, contact your local dealer or Kemlan's Head office.

IMPORTANT AUSTRALIAN CODES:

- Australian Standards AS 5601 Gas Installation
- Australian Standards AS 3000 Electrical

Important Safety Notes

- Comply with all instructions in manual including clearances to combustible material.
- Do not operate without fully assembling all components.
- All open gas fires require ventilation into the room.
- Do not connect to any other air distribution duct or system.
- An Australian approved cowl is required at flue terminal. Cowls are made from ss304 2b materials.
- Refer to the table below for flue diameter and flue cowl size.
- Air movement of systems- A decorative gas log fire must not be installed where the operation of any ventilation system, fan or air blower could in any circumstances cause the air pressure to be less than atmospheric at the appliance.
- Do not block or restrict chimney.
- After installing appliance check that the flue draws well with smoke pellet.
- Kemlan recommends that all gas fires be serviced every year.
- All gas units must be fitted by a licensed gas fitter.
- It is the responsibility of the gas fitter to follow the regulations set out in the Gas Code that dictate the procedures to follow when installing a gas appliance, particularly regarding gas pipe sizing and checking of pressures.
- All Horizon gas appliances range are recommended to use Kemlan manufactured double flue system. Sizes depend on the appliance/s purchased. The active flue is manufactured using .55mm ss304 2B and the outer flues are manufactured using .55mm galvanised steel. All flues are 900mm long as standard.

Installation

- 1 The N.D.E.I. system is supplied with all required electrical fittings. Work needs to be undertaken by a licensed electrician if extending wiring. Wiring requires clearance of minimum 100mm to flues and fireplace body due to heat. See Wiring diagram page 14. Wiring must be positively secured away from heat source.
- 2 An isolation switch needs to be provided if connecting within fireplace framework.
- 3 Build frame to specifications provided. Note: 80mm clearance above fireplace and 5mm to front surface of firebox.
- 4 Unit located on 10mm fiber cement sheeting.
- 5 Unit and flues to be installed prior to plastering.
- 6 Gas line run to desired position prior to plastering.
- 7 Clearance of 25mm to vertical flue.
- 8 Allow for a minimum flue height of 3.6 m.
- 9 All flue components to be riveted together.
- 10 Rooms with Gas Open Fires require fresh air vents of 400sq centimetres for each Decorative Gas, Coal Fire.
- 11 Vent (240mm x 90mm) supplied by Kemlan is required to ventilate chase to room

WARNING:

Do not use an unlined masonry chimney as the flue for this appliance

Rear clearances to combustible material

Low line: 25mm

Installation Instructions Kemplan Three Sided Natural Draft Electronic Ignition Gas Fireplaces

ASSEMBLY REQUIREMENTS : THREE SIDED MODEL SHOWN

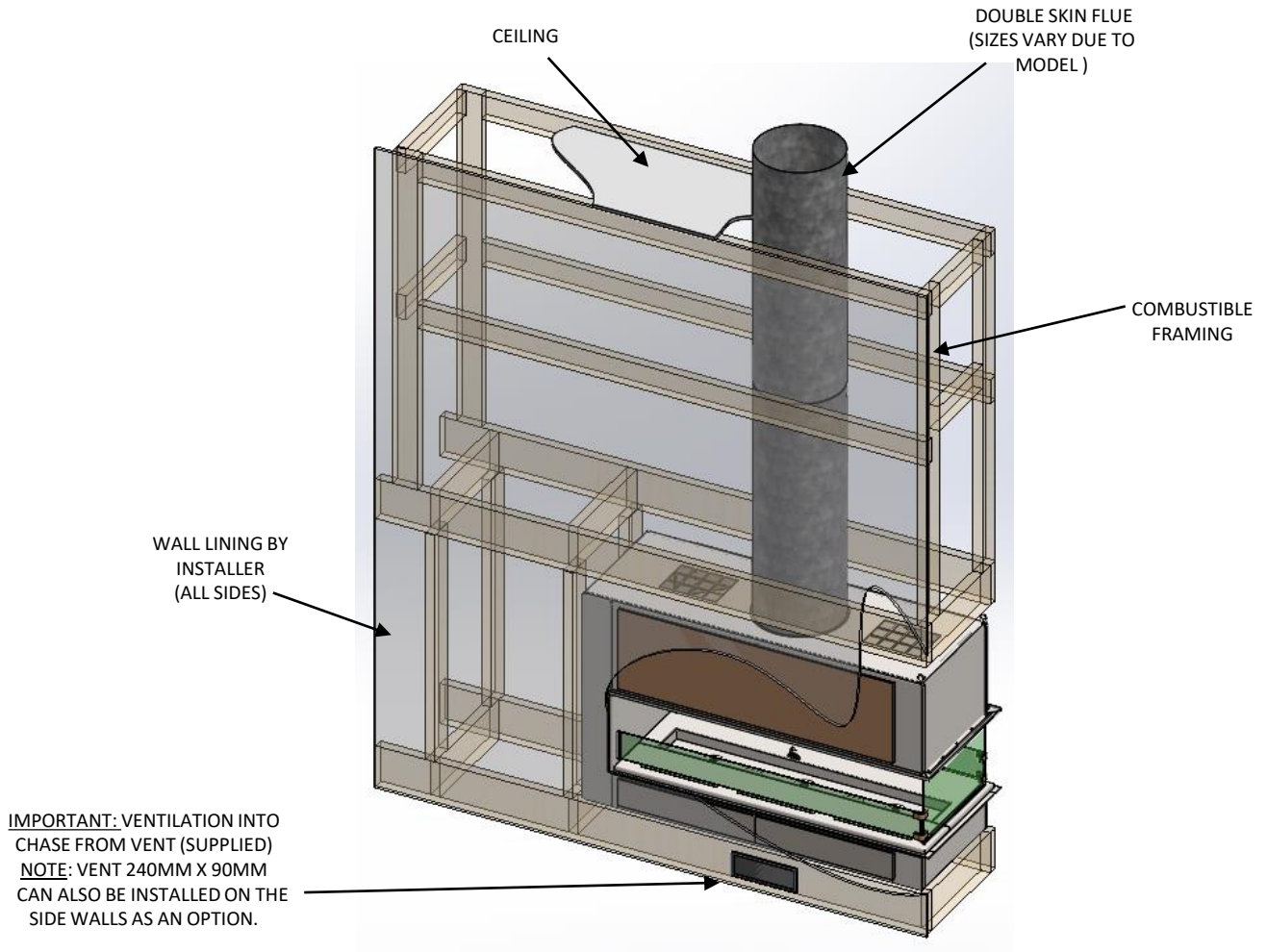

Ventilation Requirements:

Rooms with gas open fireplaces require fresh air vents according to clause 6.4.4 in AS/NZS5601. Ventilation size can be altered depending on the appliances M_j usage Vs the total room size the appliance is situated m^3 , this will be determined by a licensed gas fitter.

NOTE: The chimney in which the appliance is installed is not to be considered as a ventilation opening.

Installation Instructions Kemplan Three Sided Natural Draft Electronic Ignition Gas Fireplaces

Measurement and Specification of NDEI

HORIZON THREE SIDED :

USE EYELETS TO SUPPORT OPEN END TO FRAME ABOVE

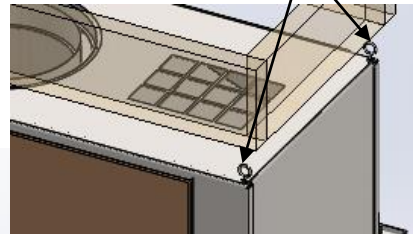

DETAIL Z

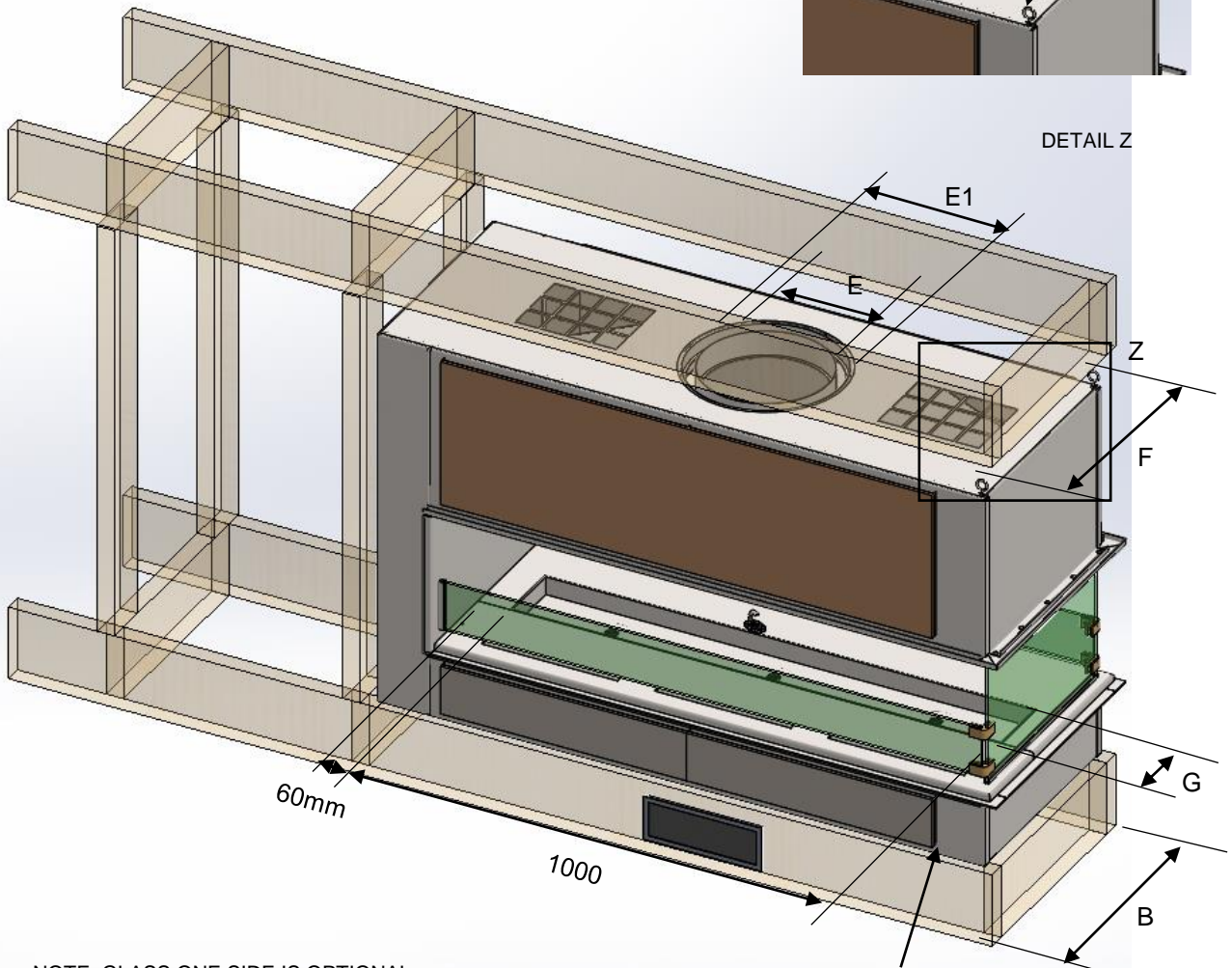

NOTE: GLASS ONE SIDE IS OPTIONAL

CEMENT SHEETING UNDER

THREE SIDED	A	B*	C	D	E	E1	F	G	H	I
1100 LOW LINE	1274	480*	870	435	10"	12"	450	135	10	15
1500 LOW LINE	1670	490*	1000	565	12"	14"	435	60	10	15

* NOT INCLUDING 10MM FIBRE CEMENT SHEETING

Installation Instructions Kemplan Three Sided Natural Draft Electronic Ignition Gas Fireplaces

Measurement and Specification of NDEI

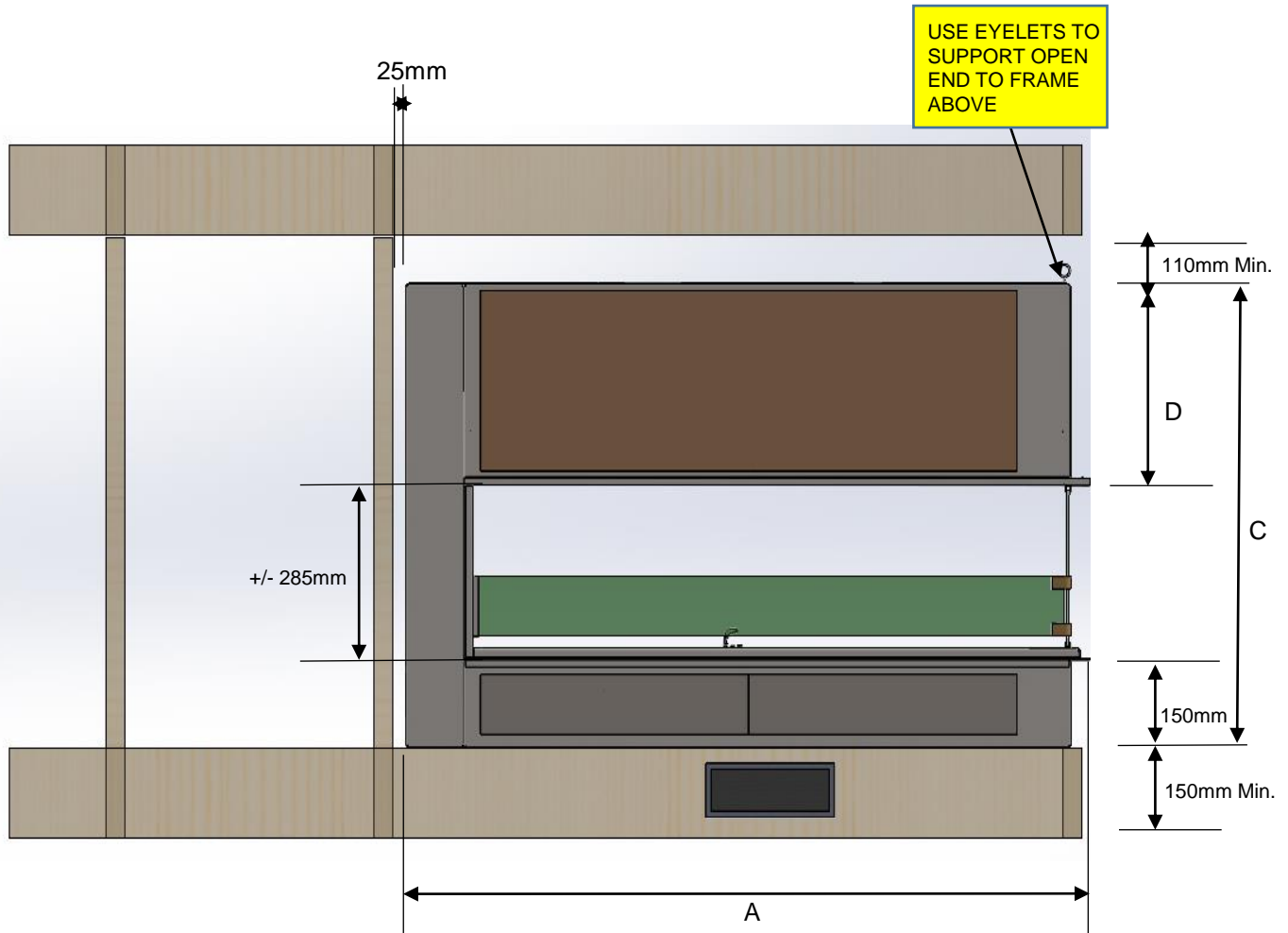
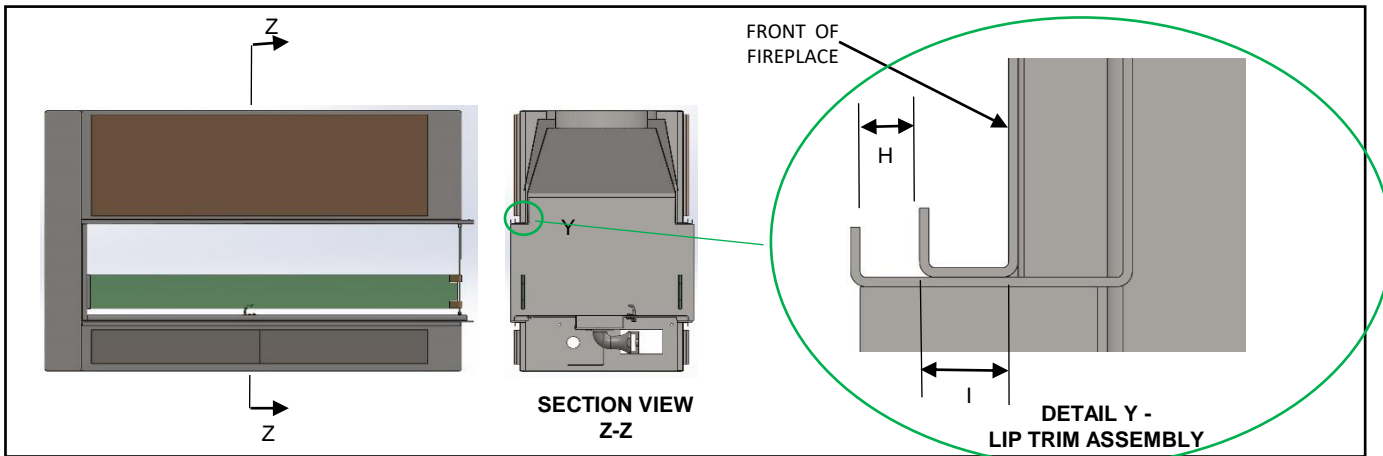

THREE SIDED	A	B*	C	D	E	E1	F	G	H	I
1100 LOW LINE	1274	480*	870	435	10"	12"	450	135	10	15
1500 LOW LINE	1670	490*	1000	565	12"	14"	435	60	10	15

* NOT INCLUDING 10MM FIBRE CEMENT SHEETING

Installation Instructions Kemplan Three Sided Natural Draft Electronic Ignition Gas Fireplaces

DRILL THROUGH THE
BEAM , RAFTER OR
FRAMING IF REQUIRED
AND PUSH THROUGH
THE THREADED ROD.

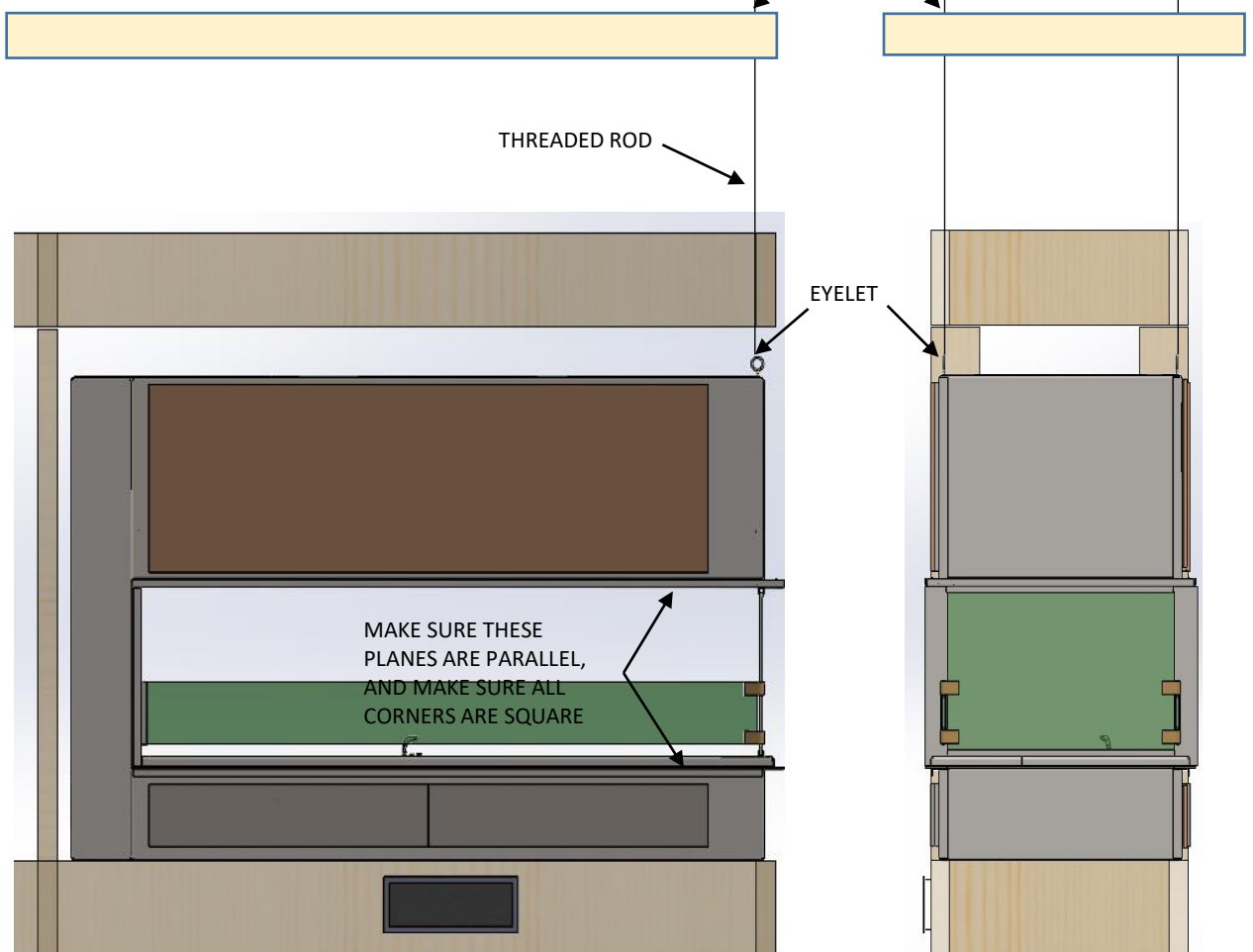

- Eyelets on the unit are supplied for attaching a turn buckle system, 6-8mm threaded rod is required with a nut and washer either side of a sufficient supporting roof member. Alternatively, a stainless steel wire with a minimum 1mm diameter or heavier and a minimum break load of 130kg can also be used.
- Once hooks have been attached to the eyelets the turn buckle can then be simply wound up to take the tension.
- Tighten the turn buckle until both the top and bottom glass runners are parallel.
- Removable glass panel can now be placed in position allowing an even gap between glass and underside of channel.

Installation Instructions Kemplan Three Sided Natural Draft Electronic Ignition Gas Fireplaces

SECTIONS

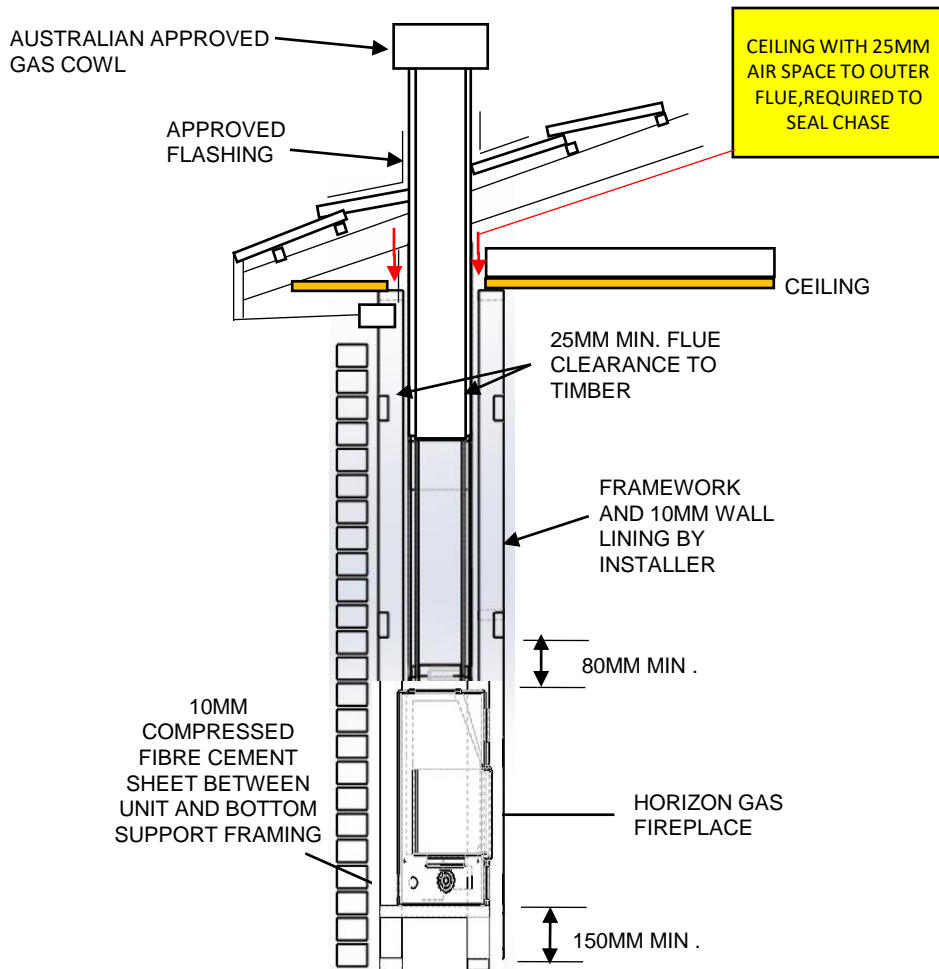

Installation Instructions Kemplan Three Sided Natural Draft Electronic Ignition Gas Fireplaces

KEMPLAN
INDUSTRIES
13 FRENCH
AVENUE
BRENDALÉ
QLD 4500

SERIAL No. xxxx

IAPMO No. GMK10737

MODEL:	MODEL NO.	GAS TYPE	BURNER	GAS CONS.	GAS CONS.	INJECTOR	INJECTOR	T.P.P.	T.P.P.
HORIZON RANGE			OPTION	MJ / HR	MJ / HR	SIZE	SIZE	K/PA	K/PA
				NAT GAS	LPG	NAT GAS	LPG	NAT GAS	LPG
SINGLE SIDED:									
700 Low Line	HLLC/P/L700	NAT GAS/LPG	700 Mk2 Pebble	55	39	3.5	1.85	1.00	2.35
			700 Mk2 Coal	55	39	3.5	1.85	1.00	2.35
			700 Ironbark Log Mk4	55	39	3.5	1.85	1.00	2.35
850 Low Line	HLLC/P/L850	NAT GAS/LPG	800 Mk2 Pebble	55	55	3.5	2.1	1.00	2.35
			800 Mk2 Coal	55	55	3.5	2.1	1.00	2.35
			850 Ironbark Log Mk4	65	55	4	2.1	1.00	2.35
1100 Low Line	HLLC/P/L1100	NAT GAS/LPG	1000 Mk2 Pebble	65	68	2.2 x 3	1.35 x 3	0.90	2.4
			1000 Mk2 Coal	65	68	2.2 x 3	1.35 x 3	0.90	2.4
			850 Ironbark Log Mk4	65	55	4	2.1	1.00	2.35
1500 Low Line	HLLC/P/L1500	NAT GAS/LPG	1400 Mk2 Pebble	65	68	2.2 x 3	1.35 x 3	0.90	2.4
			1400 Mk2 Coal	65	68	2.2 x 3	1.35 x 3	0.90	2.4
2000 Low Line	HLLC/P/L2000	NAT GAS/LPG	1800 Mk2 Pebble	70	72	2.2 x 3	1.4 x 3	0.90	2.4
			1800 Mk2 Coal	70	72	2.2 x 3	1.4 x 3	0.90	2.4
700 Cantilever	HCLC/P/L700	NAT GAS/LPG	700 Mk2 Pebble	55	39	3.5	1.85	1.00	2.35
			700 Mk2 Coal	55	39	3.5	1.85	1.00	2.35
			700 Ironbark Log Mk4	55	39	3.5	1.85	1.00	2.35
1100 Cantilever	HCLC/P/L1100	NAT GAS/LPG	1000 Mk2 Pebble	65	68	2.2 x 3	1.35 x 3	0.90	2.4
			1000 Mk2 Coal	65	68	2.2 x 3	1.35 x 3	0.90	2.4
			850 Ironbark Log Mk4	65	55	4	2.1	1.00	2.35
DOUBLE SIDED:									
700 Low Line	HLLDC/P700	NAT GAS/LPG	700 Mk2 Pebble	55	39	3.5	1.85	1.00	2.35
			700 Mk2 Coal	55	39	3.5	1.85	1.00	2.35
850 Low Line	HLLDC/P850	NAT GAS/LPG	800 Mk2 Pebble	55	55	3.5	2.1	1.00	2.35
			800 Mk2 Coal	55	55	3.5	2.1	1.00	2.35
1100 Low Line	HLLDC/P1100	NAT GAS/LPG	1000 Mk2 Pebble	65	68	2.2 x 3	1.35 x 3	0.90	2.4
			1000 Mk2 Coal	65	68	2.2 x 3	1.35 x 3	0.90	2.4
1500 Low Line	HLLDC/P1500	NAT GAS/LPG	1400 Mk2 Pebble	65	68	2.2 x 3	1.35 x 3	0.90	2.4
			1400 Mk2 Coal	65	68	2.2 x 3	1.35 x 3	0.90	2.4
2000 Low Line	HLLDC/P2000	NAT GAS/LPG	1800 Mk2 Pebble	70	72	2.2 x 3	1.4 x 3	0.90	2.4
			1800 Mk2 Coal	70	72	2.2 x 3	1.4 x 3	0.90	2.4

* THIS APPLIANCE CONSISTS OF A COMPLETE ASSEMBLY WHICH INCLUDES A FIREBOX AND FABRICATED FLUE SYSTEM. PLEASE REFER TO INSTRUCTIONS FOR CLEARANCES TO COMBUSTIBLE MATERIAL, FLUE SIZES AND METHOD OF INSTALLATION.

* PRIMARILY A DECORATIVE AND NOT A HEATING APPLIANCE.

AFTER INSTALLING APPLIANCE CHECK THAT CHIMNEY DRAWS PROPERLY.

Installation Instructions Kemplan Three Sided Natural Draft Electronic Ignition Gas Fireplaces

Gas Installation

- 1 Check unit is suitable for intended gas supply.
- 2 Note position on gas appliance on drawing specification on right hand side of appliance.
- 3 A gas cock has to be fitted prior to gas burner to allow unit to be removed for servicing.
- 4 If material has been installed around firebox and access panel below is not accessible the top plate can be removed to gain access by removing four screws and lifting out top plate.
- 5 Connection is half inch BSP fitting. Cut and deburr both ends of pipe. Fit end to gas supply point and turn on for approximately 5 seconds to clear dirt and grit out of pipe. Connect into gas valve.
- 6 Turn on the gas and check all connections for leaks using approved method for testing. Fix any leaks.

Adjusting Pressure, Pilot and Low Fire

- 1 All settings are set to operate at nominal pressure (see data plate). Test points to measure inlet and outlet pressure are located on gas valve. Unscrew brass screw on test point pressure nipples and attach manometer and read pressures with unit running. Adjust pressure to data plate requirements.
- 2 Check low fire if adjusted correctly.
- 3 Note: Failure to set pressures correctly will void warranty on the unit.

Lighting Instructions

Natural Draft Electronic Ignition Fireplaces are provided with 240volt electronic ignition systems.

An on/off wall switch is supplied and fitted with unit. The fireplace is switched on from wall switch. Power is then sent to valve to light pilot and main burner will then ignite from pilot.

Burner is turned off by turning off wall switch. System does not have a high low burner switch.

Laying the fire – Coal & Pebble

- Evenly spread a bag of Vermiculite into the burner tray. Tray should be completely filled to the top with Vermiculite to a depth of approximately 45mm.
- Unpack the coals/pebbles contained in a clear plastic bag and lay a row of coals/pebbles on the vermiculite along the back of the burner tray leaving approximately 12-15mm between them.
- Leave spaces at the edges to allow free flow of gas.
- Place a further row of coals/pebbles directly in front of the first row but staggered so that the second row of coals are behind the gaps of the first row leaving approximately 12-15mm between the rows of each coal/pebble.
- Lay further rows of staggered coals/pebbles depending on the size of the basket grate.
- Once the bottom layer is completed, build up 2-3 tiers of coals in a honeycomb pattern to form an elongated pyramid.
- Lay the coals/pebbles so that some irregularity to the pile through which the flames may lick, is created.
- Your aim is to build “windows” into the fire through which the radiant effect may show but at the same time, not leaving such large gaps between the coals/pebbles that excessive air may enter and “damp down” the red glow.
- After the fire has been alight for 15 minutes, you may wish to add the odd coal/pebble or even relay the fire completely. Allow to cool before touching the coals/pebbles.
- Experience will enable you to obtain a pleasing appearance with suitable heat output, but please bear in mind that it is important to maintain the general pattern described above and indicated in illustrations.

**SEE NEXT PAGE FOR COAL & PEBBLE
DIAGRAMS**

Installation Instructions Kemplan Three Sided Natural Draft Electronic Ignition Gas Fireplaces

Laying the fire – Coal & Pebble



MARK 2 COALS 700/800 – 600 X 155



MARK 2 PEBBLES 700/800 – 600 X 155



MARK 2 COALS 1000 – 992 X 135



MARK 2 PEBBLES 1000 – 992 X 135

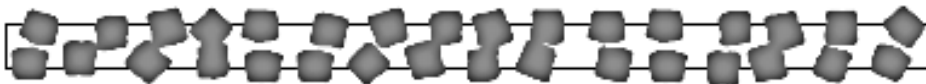

MARK 2 COALS 1400 – 1400 X 64

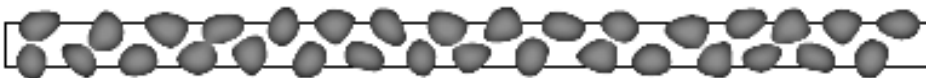

MARK 2 PEBBLES 1400 – 1400 X 64

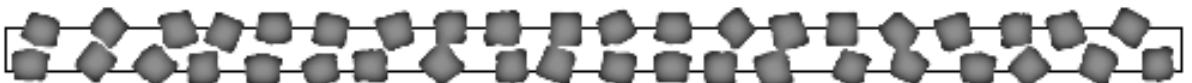

MARK 2 COALS 1800 – 1800 X 64



MARK 2 PEBBLES 1800 – 1800 X 64

Installation Instructions Kemplan Three Sided Natural Draft Electronic Ignition Gas Fireplaces

Laying the fire - 850 Ceramic Log

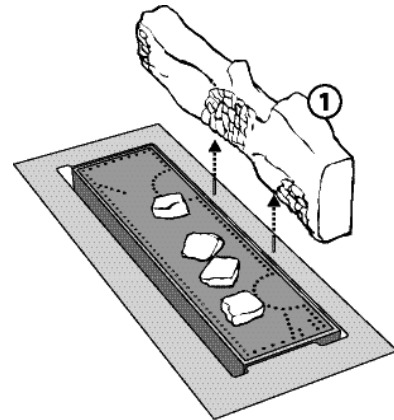
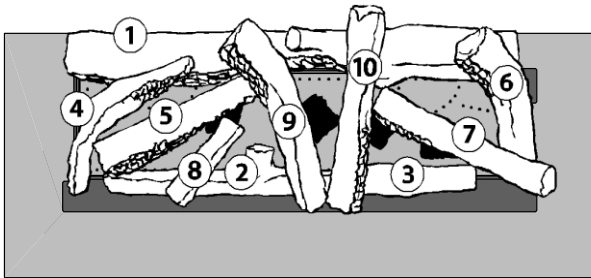

POSITIONING OF ALL LOGS

- It is important to follow the log recommended positioning.
- Log NO. 6, 10, 9 and 4 must be pinned to rear log with pins provided.
- Not doing so can adversely effect the operation of the appliance.
- This diagram shows the recommended log positions, when viewed from above.

2. LOCATE LOG NO. 1 :

This is the largest log that is positioned at the rear of the grate. Two locating pins are positioned at the rear of the burner. The large log has two holes on the underside to position in place.

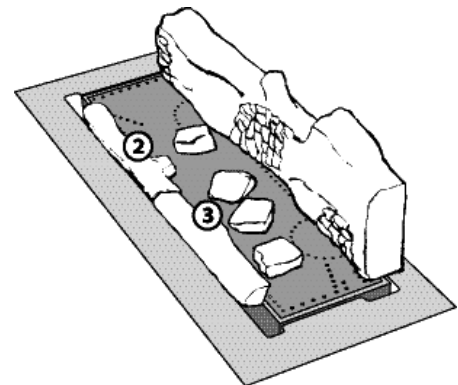
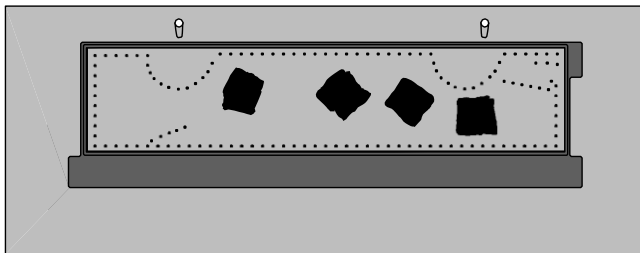

1. LOCATE 4 CERAMIC COALS :

Four ceramic coals are supplied with the burner base. These coals must be laid in the position indicated on the drawing with the taller coals on the ends and smaller coals in-between.

3. LOCATE LOG NO'S 2 & 3

Two front log NO'S. 2 & 3 are supplied to fit into the space between the metal frame and the ceramic base. These logs do not cover the front burner ports but are designed to deflect the front flame back into the fire.

LOGS

Only use logs supplied by the manufacturer as other logs may effect combustion performance

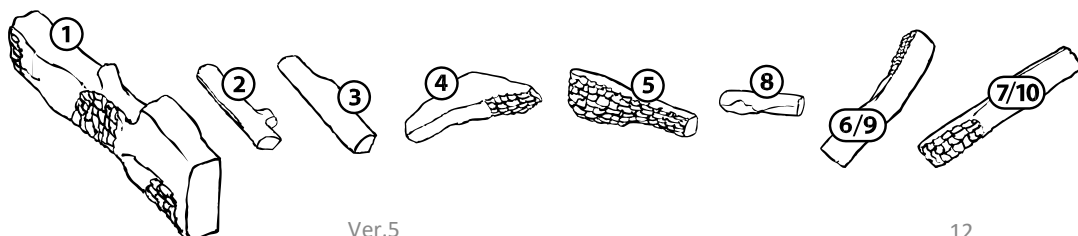

Installation Instructions Kemplan Three Sided Natural Draft Electronic Ignition Gas Fireplaces

Laying the fire – 700 Ceramic Log

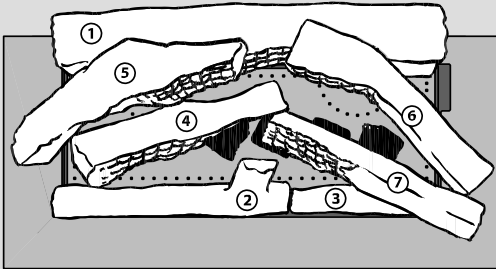

POSITIONING OF ALL LOGS

- It is important to follow the log recommended positioning.
- Not doing so can adversely effect the operation of the appliance.
- This diagram shows the recommended log positions, when viewed from above.

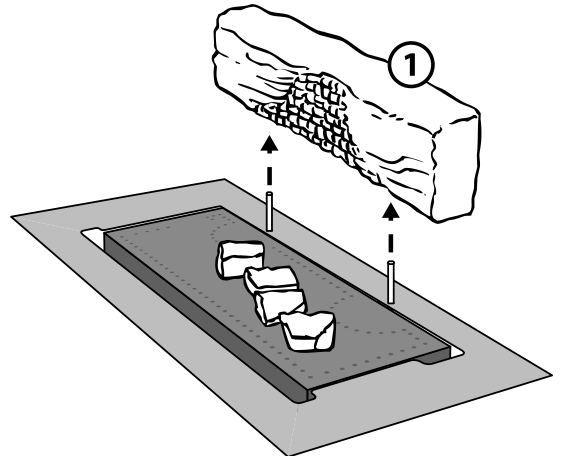

2. LOCATE LOG NO. 1:

This is the largest log that is positioned at the rear of the grate. Two locating pins are positioned at the rear of the burner. The large log has two holes on the underside to position in place.

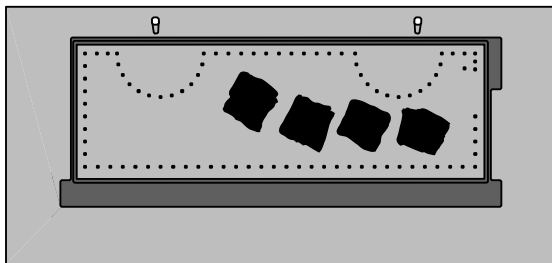

1. LOCATE 4 CERAMIC COALS:

Four ceramic coals are supplied with the burner base. These coals must be laid in the position indicated on the drawing with the taller coals on the ends and smaller coals in-between

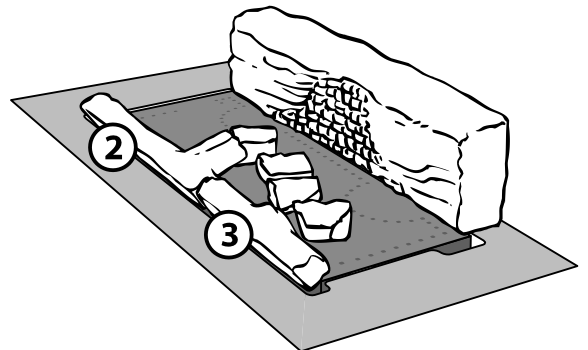

3. LOCATE LOG NO'S 2 & 3:

Two front log no's. 2 and 3 are supplied to fit into the space between the metal frame and the ceramic base. These logs do not cover the front burner ports but are designed to deflect the front flame back into the fire

LOGS

Only use logs supplied by the manufacturer as other logs may effect combustion performance

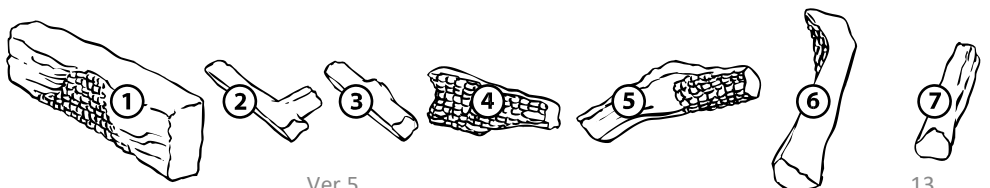

Installation Instructions Kemplan Three Sided Natural Draft Electronic Ignition Gas Fireplaces

Laying the fire - 700 Ceramic Log

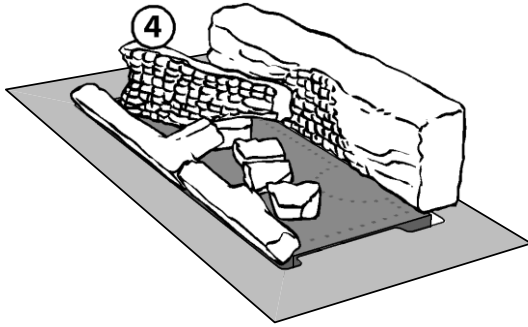

4 . LOC ATE LOG NO. 4.

This log is placed with the thinner edge on the smaller coal. The charred effect is facing towards the front of the burner. The whole log is positioned on the burner base.

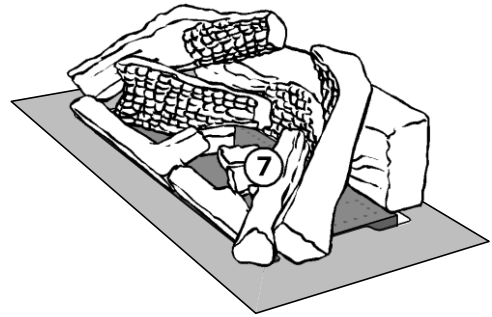

6 . LOC ATE LOG NO. 7 :

The charred effect of the log is positioned on the smaller coal in the centre of the burner on the right hand side.
The right hand side of the log is positioned between the front metal upright on the side.

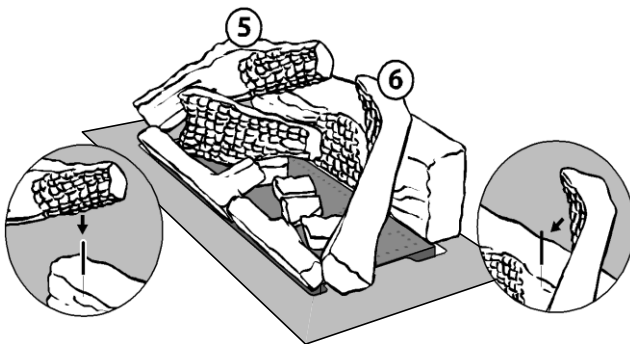

5 . LOC ATE LOG NO'S 5 & 6 .

Log no.5 is positioned onto the larger rear log on the left hand side. The charred effect faces inwards and the bark effect on the outside. The left hand side of the log is positioned between the metal uprights on the side of the grate. Log no. 6 is positioned in the same manner but on the right hand side of the burner with the right hand side of the logs positioned between the metal uprights of the grate. Two pins are provided to firmly position these two logs onto the large rear log (no. 1).

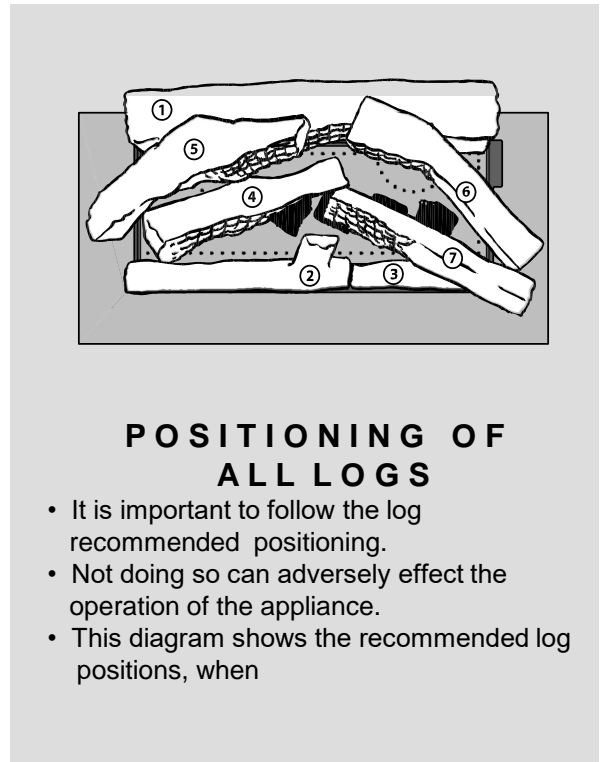

POSITIONING OF ALL LOGS

- It is important to follow the log recommended positioning.
- Not doing so can adversely effect the operation of the appliance.
- This diagram shows the recommended log positions, when

LOGS

Only use logs supplied by the manufacturer as other logs may effect combustion performance

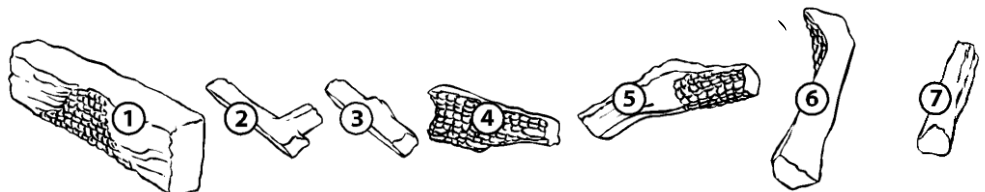

Installation Instructions Kemlan Three Sided Natural Draft Electronic Ignition Gas Fireplaces

Commissioning Procedure

Installed correctly the burner should not emit any fumes into the room. The following procedure should be undertaken to test that the unit is operating correctly.

- 1 After unit has been operating for a short period a smoke match, smoke tube, carbon dioxide analyser or similar should be directed at the top opening of the unit.
- 2 This procedure should be undertaken with the following conditions in the room:
 - Open or closed windows
 - Operation of extraction/exhaust fans, range hoods etc.
 - Operation of other gas appliances
 - Operation of optional appliance fan at any speed.
- 3 Should any spillage be detected the cause must be rectified before allowing commissioning of unit.
4. Please test appliance operation before leaving.

User Instructions

1. **WARNING NOTE:** Properly installed and operated this appliance will not leak gases. Persistent fume emission must not be tolerated. If fume emission does exist, then the following immediate action should be taken.
 - A Open doors and windows to ventilate room.
 - B Turn the fire off.
 - C Check for flue blockage and clear if necessary.
 - D Do not attempt to relight the burner until the cause of the emission has been identified and rectified. Should assistance be required contact nearest agent.
 - E The gas burner is designed to work in a Kemlan Horizon electronic power flue ignition system. Working correctly there will be no spillage. Unit should cut out if not enough draw to ensure proper functioning.
- 2 Initially the Kemlan coal fire may burn with a slightly blue flame. After approximately 20 minutes the fire will settle down and burn with a yellow flame.
- 3 As with all gas fires your gas coal/pebble or log fire should be regularly serviced. We recommend once each year. Service information for an authorised person to follow has been set out in attached leaflet.
- 4 **PLEASE NOTE:** Only logs provided by Kemlan should be used with this appliance.
- 5 **DO NOT** place articles on or against this appliance.
 - DO NOT** use or store flammable materials near this appliance.
 - DO NOT** spray aerosols in the vicinity of this appliance whilst it is in operation.
 - DO NOT** modify this appliance.Primarily a decorative appliance not certified as a space heater.
- 6 The appliance is a live fuel effect product designed to operate with luminous flames and may exhibit slight carbon deposition.
7. The guard is fitted to this appliance to reduce the risk of fire or injury from burns and no part of it should be permanently removed.

SERVICE - WARNING: ONLY TO BE SERVICED BY AN AUTHORISED PERSON

IMPORTANT: THIS APPLIANCE REQUIRES FRESH AIR TO OPERATE SAFELY. THE ROOM WHERE THIS APPLIANCE IS INSTALLED MUST HAVE PERMANENT VENTILATION FROM OUTDOORS, THIS VENTILATION MUST NOT BE MODIFIED.

Installation Instructions Kemplan Three Sided Natural Draft Electronic Ignition Gas Fireplaces

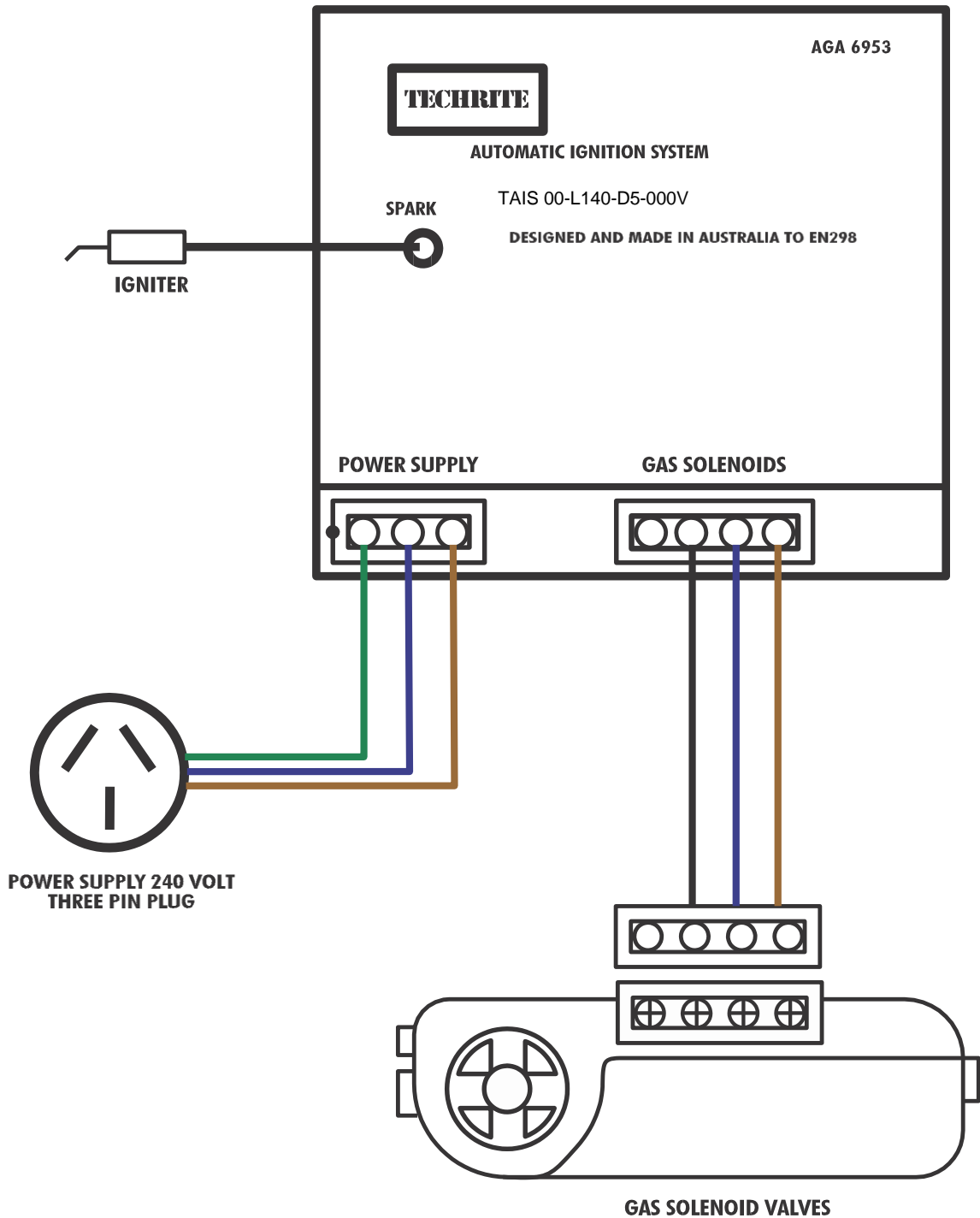

For further service information contact Kemplan Australia
Head Office –13 French Avenue, Brendale, Queensland 4500
Telephone –PH: (07) 3490 5500

Installation Instructions Kemplan Three Sided Natural Draft Electronic Ignition Gas Fireplaces

Service Instructions for Direct Ignition and Power Flue Horizon fireplaces.

POWER FLUE SERVICE INSTRUCTIONS

PROBLEM	POSSIBLE CAUSE	CORRECTIVE ACTION
PILOT WILL NOT LIGHT WITH FAN WORKING	1) NO GAS	- CHECK FOR GAS SUPPLY AND TURN ON ALL CONNECTIONS - CHECK GAS PRESSURE - CHECK PILOT AND CLEAN INJECTOR
	2) NO SPARK AT PILOT	- CHECK ALL CONNECTIONS - CHECK SPARK ELECTRODE CONNECTIONS AND REPLACE ELECTRODE IF DAMAGED. - CHECK SOLENOID CONNECTIONS AT VALVE - CHECK PRESSURE SWITCH FUNCTIONS IN FAN. Note :flash codes/red LED for pressure switch functions on module.
FAN DOES NOT TURN ON	1) POWER SUPPLY	- TURN ON ALL POWER SWITCHES - CHECK ALL CONNECTIONS - CHECK FAN ON INDEPENDENT POWER SWITCH
FAN COMES ON. PILOT ON. MAIN BURNER DOES NOT LIGHT	1) FLAME SENSOR NOT SENDING SIGNAL TO OPEN VALVE	- CHECK ELECTRODE IS IN PILOT FLAME - CLEAN ELECTRODE - CHECK ELECTRODE CONNECTIONS - REPLACE ELECTRODE IF DAMAGED
	2) MODULE NOT SENDING SIGNAL TO OPEN VALVE	- CHECK CONNECTIONS - REPLACE MODULE
	3) FAULTY VALVE	- REPLACE VALVE
FLAME FAIL LOCKOUT UNIT HAS DETECTED LOSS OF FLAME AND LOCKED OUT	1) POWER FAILURE	- TURN ON/OFF SWITCH OFF AND ON AGAIN TO RESET ONCE POWER ESTABLISHED
	2) GAS SUPPLY	- CHECK GAS PRESSURE AND ADJUST - RESET AT ON/OFF SWITCH
	3) DIRTY ELECTRODE	- CLEAN ELECTRODE OR REPLACE
	4) PILOT BLOCKED	- CLEAN PILOT INJECTOR
	5) PRESSURE SWITCHES	NOTE:FLASH CODES (RED LED) WITH ENCLOSED INSTRUCTIONS TO IDENTIFY PRESSURE SWITCH PROBLEMS.

Installation Instructions Kemplan Three Sided Natural Draft Electronic Ignition Gas Fireplaces

DIRECT IGNITION

PROBLEM	POSSIBLE CAUSE	CORRECTIVE ACTION
PILOT WILL NOT LIGHT	1) NO GAS	<ul style="list-style-type: none"> - CHECK FOR GAS SUPPLY AND TURN ON ALL CONNECTIONS - CHECK GAS PRESSURE - CHECK PILOT AND CLEAN INJECTOR
	2) NO SPARK AT PILOT	<ul style="list-style-type: none"> - CHECK ELECTRIC SUPPLY AND TURN ON ALL SWITCHES - CHECK ALL CONNECTIONS - CHECK SPARK ELECTRODE CONNECTIONS AND REPLACE ELECTRODE IF DAMAGED. - CHECK SOLENOID CONNECTIONS AT VALVE
PILOT LIGHTS BUT VALVE DOES NOT OPEN TO LIGHT MAIN BURNER	1) FLAME SENSOR NOT SENDING SIGNAL TO OPEN VALVE	<ul style="list-style-type: none"> - CHECK ELECTRODE IS IN PILOT FLAME - CHECK ELECTRODE CONNECTIONS - CLEAN ELECTRODE - CHECK ELECTRODE FOR DAMAGE - REPLACE ELECTRODE
	2) MODULE NOT SENDING SIGNAL TO OPEN VALVE	- REPLACE MODULE
	3) FAULTY VALVE	- REPLACE VALVE
FLAME FAIL LOCKOUT UNIT HAS DETECTED LOSS OF FLAME AND LOCKED OUT	1) POWER FAILURE	- TURN ON/OFF SWITCH OFF AND ON AGAIN TO RESET ONCE POWER ESTABLISHED
	2) GAS SUPPLY	<ul style="list-style-type: none"> - CHECK GAS PRESSURE AND ADJUST - RESET AT ON/OFF SWITCH
	3) DIRTY ELECTRODE	- CLEAN ELECTRODE OR REPLACE
	4) PILOT BLOCKED	- CLEAN PILOT INJECTOR
	5) PRESSURE SWITCHES	NOTE: TECHRITE IGNITION PACK FLASH CODES (RED LED) TO IDENTIFY PROBLEM.

Installation Instructions Kemplan Three Sided Natural Draft Electronic Ignition Gas Fireplaces

Trouble shooting guide for Techrite ignition pack

Warning: This is a 240VAC module. All connections to the module are 240V (except ignition cable and flame sense). **Ensure power is switched off** before checking any connection or replacing any components.

There is a red LED (light) and a green LED (light) on the blue ignition box. If a fault occurs the sequence of the flashing red light indicates the fault. These codes are listed below.

The green light indicated the ignition box is sensing the flame.

Atmospheric Models

Flash Code (Red LED)		Meaning	Possible Cause
Long	short		
1	0	Running OK	Appliance running correctly (Green LED will be on)
2	1	Maximum retries exceeded Unit has tried to light and not detected flame.	Check spark electrode for damage and clean if necessary. Check electrode connection. Check solenoid connections. Check gas supply.
2	2	Flame fail lockout. Unit has detected loss of flame. It has tried re-ignition and locked out	Check electrode, lead and connection. Check gas supply.

Fan Forced Models

The codes above still apply plus the codes below.

1	2	Pressure switch off Pressure switch contacts have not closed.	Check if fan starts. If fan starts OK, check pressure switch.
1	3	Pressure switch on Pressure switch contacts have not opened after last heat cycle.	Pressure switch is faulty and is stuck on, or fan has not turned off.

Installation Instructions Kemplan Three Sided Natural Draft Electronic Ignition Gas Fireplaces

Flash Code (Red LED)	Meaning	Possible Cause
3 1	Pressure switch fail unit has started and during heat cycle the pressure switch has opened	Check combustion fan. Check pressure switch and connections. Check flue for obstructions

Notes:

The ignition unit is polarity sensitive. If the active and neutral cables are not wired correctly, the unit will not sense a flame, the green LED will not come on. The heater will light but will turn off almost immediately as a result.

If the heater lights but the igniter keeps sparking then the unit shuts down after 3 to 5 seconds, incorrect polarity is a likely cause. The fault code on the module red LED will be 2 long and 1 short.

Before carrying out repairs, **turn off the power**, visually inspect all cables and connections for damage or corrosion.

On start up, once the unit has passed the self test (and pressure switch is closed on fan forced models) you should be able to hear a clunk from the gas valve as it opens. If no sound from the gas valve, check connections. If the valve clunks but no ignition, check gas supply and spark electrode.

On fan forced models, if you suspect a pressure switch fault, you can blow on the input to the switch and you should be able to hear it switch. If you have a multi meter you can check if the switch is opening and closing as pressure is applied. **Be certain to turn off the power before disconnecting or checking switch!**

TAIS Flash Codes LED Flash Code Descriptions

Flash Code (Long flashes– short flashes)	Description
0-2	Normal Start Up Operation
1-0	Normal Running State
1-1	Flame failure
1-2	Waiting for pressure switch ON
1-3	Waiting for pressure switch to go OFF
1-4	Waiting for flame sense to go OFF
1-5	Post Purge in progress
2-1	Maximum retries exceeded
2-2	Lockout due to flame failure
2-3	Hardware failure on Combustion fan drive, or microcontrollers disagree
2-4	Hardware failure on GAS1 valve drive, or microcontrollers disagree
2-5	Hardware failure on GAS2 valve drive, or microcontrollers disagree
2-6	Hardware failure on flame sensor
2-7	Relay Enable signal hardware failure (stuck in ON state)
3-1	Lockout due to pressure switch opening
3-2	Lockout due to EE memory corruption
3-3	Lockout due to inter-microcontroller communications link problem
3-4	Lockout due to comms error timeout

WARRANTY FOR HORIZON MODELS

1. Provided the appliance has been correctly installed according to instructions, Kemlan guarantee the cost of replacing parts and the labour in connection therewith for a period of 12 months from the date of installation.

2. THIS WARRANTY DOES NOT COVER –

- 2.1 Failure to comply with manufacturer's operation instructions.
- 2.2 Normal wear and tear or damage caused by incorrect installation.
- 2.3 Any form of rust and/or corrosion to the painted finish of the heater.
- 2.4 Damage caused by water ingress.
- 2.5 Cost of removal of defective heater or re-installation of replacement heater.
- 2.6 Failure to use fireplace components supplied by Kemlan Industries Pty Ltd.
- 2.7 Cost of inspection for damaged heater.

3. CLAIMS –

- 3.1 Should any defects occur, contact the Kemlan distributor from whom you purchased the heater.
 - 3.2 Under this warranty the defective parts will be repaired or replaced by Kemlan's option, free of charge.
4. The fireplace installation must comply with the relevant local statutes, ordinances, regulations and by-laws.

PLEASE COMPLETE AND RETAIN THIS SECTION FOR YOUR RECORDS

Purchased from:
Address:
Date of Purchase: